

GENERAL CHARACTERISTICS

Magnetostrictive continuous level transmitters base their operation on the physical principle called Wiedemann effect and allow a continuous and precise measurement of liquid levels. The electronic unit sends a pulse to a waveguide contained in the measuring rod; the magnetic float intercepts the pulse generating an echo that is detected by the same electronic unit.

The elapsing time between the emission of the pulse and its recognition is directly proportional to the position of the float, and then to the value of the level to be measured.

- **Stainless steel – AISI 316**
- 1 analog output, current or voltage.
- 2 analog outputs, current and voltage.
- 2 factory programmable PNP digital outputs.
- RS485 serial output, Valco protocol.
- Programming via dedicated handheld computer VSP.130, on request
- Up to 2, 9 m length.
- Working pressure up to 50 bars depending on the used float.
- Operating ambient temperature -30 / +70 °C, RH 90%.
- Standard working temperature up to 105 °C
150 °C working temperature on request.
- Minimum degree of protection IP67.



See MULTISIGNAL

TECHNICAL DATA

Tab.1

Power supply	18 ÷ 30 Vcc	Analog output	Current	• 4-20mA	420
Power consumption	< 100 mA		Voltage	0-5V	005
Signal output resolution	< 1 mm			0-10V	010
Accuracy	≤ 1 mm		0,5-4,5V	545	
Room temperature	-30 / +70°C	Communication output	Current / Voltage	4-20mA/0-10V	420/10
Process temperature	105° C 150°C with heat sink		RS485 - Valco protocol		RS485
Measuring length L0	2, 9 m - max. 2, 8 m - max. - 150°C application	N.2 Digital output factory programmable	2 x PNP - not protected maximum load 100mA		2PNP
Electrical connection	S5 Conec M12 x 1, 8 poles	Programming of instrument	Via dedicated handheld computer VSP.130 available on request		
Protection class	IP67				

- Standard, others signal output and indicated option on request

FLOATS

Tab.2



Material	Stainless steel – AISI 316			
Specific gravity	0,75	0,55	0,65	0,7
Max. pressure – Bar	30	10	10	50
Max. temperature – Class	L = 105°C - R = 150°C			

ELECTRICAL OUTPUT

Tab.3

S5	L	105°C	Standard	Anodized aluminum
	R	150°C	With heat sink	

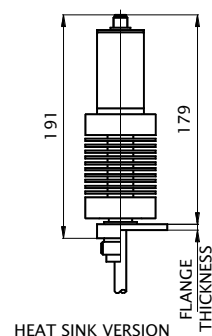
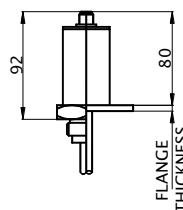

PROCESS CONNECTIONS Tab.4

Type of float	Mounting from outside						
	25	32	40	50	FSHX	DN65	DN125
	1"	1-1/4"	1-1/2"	2"	Flange	Flange	Flange
S29	G	G-C-N	G-C-N	-	•	-	-
S32	G	G-C-N	G-C-N	-	•	-	-
S41	-	-	G-C-N	G-C-N	-	•	-
S52S	-	-	-	G-C-N	-	•	-
S100	-	-	-	-	-	-	•

Male thread

G	C	N
Parallel UNI 228/1	Conical UNI 7/1	Conical NPT

Available materials

S
AISI-316

DN = Available materials

S	C
AISI-316	Steel on request

FLANGES Dimensions in mm.

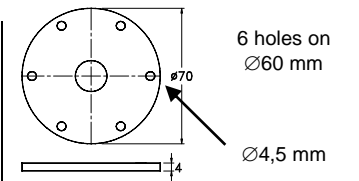

FSHX

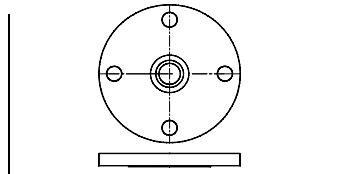

DN = UNI - DIN - ANSI Flanges

A Flanged connection
A1 Threaded

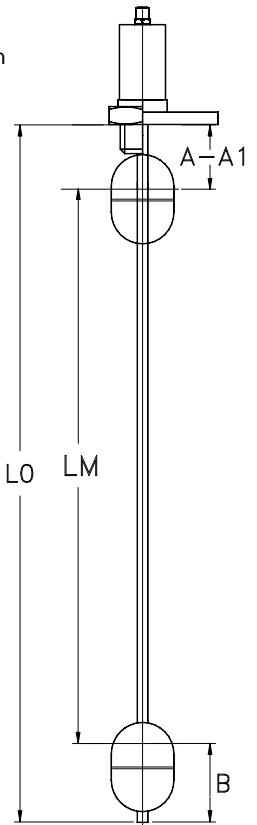

WIRING

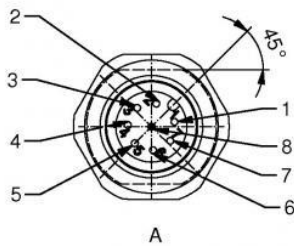

PIN	SIGNAL
1	RS485 - line B
2	Power supply +V
3	RS485 - line A
4	Ground
5	Analog output - voltage
6	Analog output - current
7	Digital output - PNP2
8	Digital output - PNP1

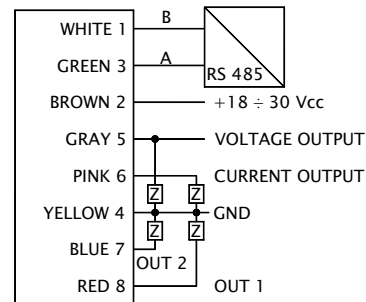

DIMENSIONS mm. Tab.5

The dimension L0 - LM is measured from the stop of the fitting (A1) or flange (A) connection. Tolerance on dimension L0 - LM ± 3 mm.

	S29	S32	S41	S52 (S)
A	75	75	75	75
A1	75	75	75	75
B	65	65	65	65

Damping tube	- S	- V
On request	AISI-316	PVC

NOMENCLATURE

LCM	S52	1300 / 1400	S	- S	50	G	S	420	S5	L
•										
	•									
		•								
			•							
				•						
					•					
						•				
							•			
								•		
									•	
										•

Type	Tab.2
Float	Tab.2
Measuring length LM / Total length L0 (mm)	Tab.5
Stem material	Tab.2-4
Damping tube (option)	Tab.5
Process connection dimension	Tab.3
Process connection thread	Tab.4
Process connection material	Tab.4
Analog output and options required	Tab.1
Electrical output.	Tab.3
Temperature class	Tab.2-3

CABLE- PLUG

Connection cable 2m. with connector M12x1

Accessory on request